



in the office
FURNITURE

5

TWENTY FIVE 50 BENCHING

twentyfive50 benching systems



The Twentyfive50 benching system is aesthetically light and balanced, and delivers creative solutions to a variety of space planning and functional needs. The workplace solution options inspire innovation, and promote employee engagement and teamwork. Twentyfive50 offers a unique workplace identity that can express your organizational culture and brand and creates a productive work environment.

twentyfive50 executive



twentyfive50 management



twentyfive50 - executive

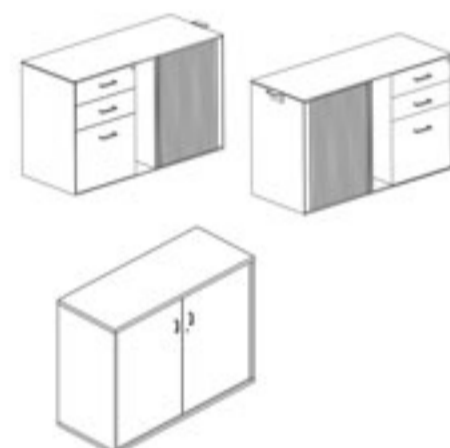
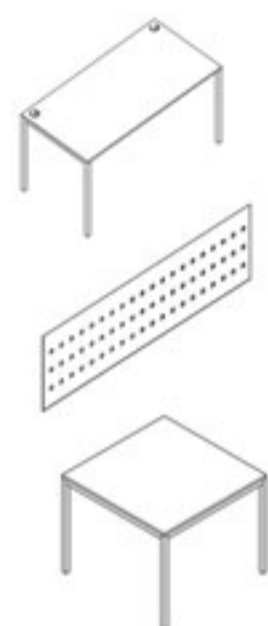

description	size	code
executive desking - freestanding - includes wire mesh cable tray - 2 wire management portholes - adjustable ferrules - steel frame available in white, black or silver - specify on order	2000(w) x 1000(d) x 730(h) 1800(w) x 900(d) x 730(h)	DESK01 DESK02
modesty panel steel - includes brackets - steel modesty available in white black or silver - specify on order	1600(w) x 350(h)/2000 1400(w) x 350(h)/1800	ZMS009 ZMS010
meeting tables - 4 cross beams no centre leg - 4 cross beams no centre leg - 2 cross beams no centre leg - steel frame available in white, black or silver - specify on order	1200(w) x 1200(d) x 730(h) 1500(w) x 1510(d) x 730(h) 900(w) x 900(d) x 730(h)	TTFMEET1 TTFMEET2 TTFMEET5
pedenza - 2S1F drawers - drop in pen & pencil tray - excludes shelves - need to order 2/3 shelf - includes storage bracket - in order to file suspended files order 400w cradles for A4 filing only	1250(w) x 500(d) x 730(h) - lhs (silver) 1250(w) x 500(d) x 730(h) - lhs (charc) 1250(w) x 500(d) x 730(h) - rhs (silver) 1250(w) x 500(d) x 730(h) - rhs (charc)	PEDTFF1L PEDTFF2L PEDTFF1R PEDTFF2R
wall unit base - includes 1 laminate shelf	900(w) x 500(d) x 900(h)	WUNBA

twentyfive50 - management

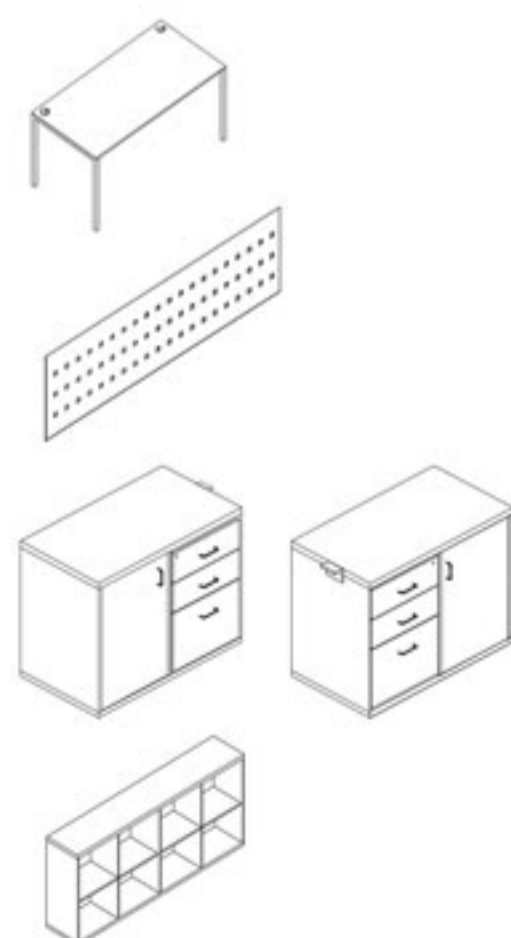

description	size	code
managerial desking - managerial & pa size desk - freestanding - includes wire mesh cable tray - 2 wire management portholes - adjustable ferrules - steel frame available in white, black or silver - specify on order	1800(w) x 900(d) x 730(h) 1800(w) x 750(d) x 730(h) 1600(w) x 750(d) x 730(h)	DESK02 DESK03 DESK04
modesty panel steel - includes brackets - steel modesty available in white black or silver - specify on order	1400(w) x 350(h)/1800 1200(w) x 350(h)/1600	ZMS010 ZMS011
hinge door pedenza - left /right hand side - 2 std drawers & 1 deep filler drawer - central locking + door lock - includes shelf - includes storage bracket - power management outlets - in order to file suspended files order 400w cradles for A4 filing only	900(w) x 450(d) x 730(h) - rhs 900(w) x 450(d) x 730(h) - lhs	PEDTFF5 PEDTFF6
8 div pigeon organiser - 22mm top & bottom - fits lever arch files	1510(w) x 500(d) x 1100(h)	PIG8DIV

twentyfive50 personal assistant







twentyfive50 boardroom



twentyfive50 standing meeting table



twentyfive50 - personal assistant

	description	size	code
	p.a. desking	1 800(w) x 750(d) x 730(h)	DESK03
	- managerial & pa size desk	1 600(w) x 750(d) x 730(h)	DESK04
	- freestanding	1 500(w) x 750(d) x 730(h)	DESK04A
	- includes wire mesh cable tray	1 200(w) x 750(d) x 730(h)	DESK05
	- 2 wire management portholes		
	- adjustable ferrules		
	- steel frame available in white, black or silver - specify on order		
	modesty panel steel	1 400(w) x 350(h)/1 800	ZMS010
	- includes brackets	1 200(w) x 350(h)/1 500/1 600	ZMS011
	- steel modesty available in white black or silver - specify on order	900(w) x 350(h)/1 200	ZMS012
	L - extension	1 050(w) x 600(d) x 730(h)	LEXT02
	- 600mm leg	750(w) x 600(d) x 730(h)	LEXT01
	- including managerial brackets		
	- fits onto all straight, dual & executive steel desks		
	- includes 2 x small link plates		
	- adjustable ferrules		
	- steel frame available in white, black or silver - specify on order		
 	personal assistant organiser	1 200(w) x 350(d) x 790(h)	PAO1
	for use on top of 1200(w) credenza		
	1S1F mobile pedestal	400(w) x 525(d) x 590(h)	PB2009
	- drop in pen & pencil tray		

twentyfive50 - boardroom

	description	size	code
	boardroom table	1 800(w) x 900(d) x 730(h)	TTBOARD1
	- 2 Cross beams no centre leg	1 800(w) x 1 200(d) x 730(h)	TTFBOARD2
	- 4 Cross beams no centre leg	2 400(w) x 1 200(d) x 730(h)	TTFBOARD3
	- 4 Cross beams 2 centre leg	2 700(w) x 1 200(d) x 730(h)	TTFBOARD4
	- 4 Cross beams 2 centre leg		
	- steel frame available in white, black or silver - specify on order		
	server unit 3 door	1 500(w) x 600(d) x 950(h)	TTFSERV2
	- includes 3 shelves		
	- 3 hinge doors		
	- accommodates std bar fridge		

twentyfive50 - standing meeting table

	description	size	code
	standing meeting table	1 800(w) x 900(d) x 1 022(h)	TTFMEET3
	- 2 cross beams support under top	1 500(w) x 900(d) x 1 022(h)	TTFMEET4
	- base frame structure		
	- steel frame available in white, black or silver - specify on order		

twentyfive50 vertebra with open top filer



The Vertebra storage system offers the perfect solutions for all the storage functionality you need: Filing, Organization, Versatility and Space Utilization.

The Vertebra storage system is made up of a modular top storage unit, and bottom storage unit.





The top storage unit is comprised of a pinboard section, and adjacent to the pinboard section, is a choice of either open storage or roller door storage compartments.

The bottom storage unit consists of a hinge door compartment, with a single shelf, and adjacent to the hinge door compartment, is a drawer unit consisting

of 2 drawers (One single drawer, with a drop in pen and pencil tray and one drawer as a deep filer). The Vertebra storage system has an integrated cable management

compartment, placed between the top and bottom storage units, and is primarily used for reticulation purposes. Power and data cables are conveniently delivered to workstations through cable management ports, located on the sides, middle and back of the Vertebra storage units.

twentyfive50 - vertebra with open top filer

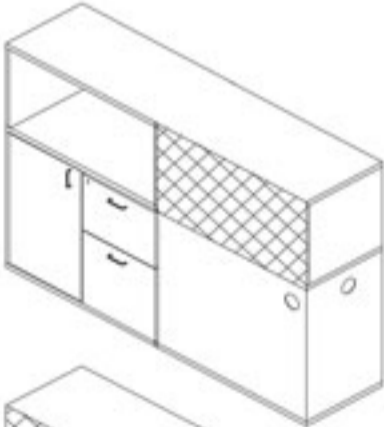
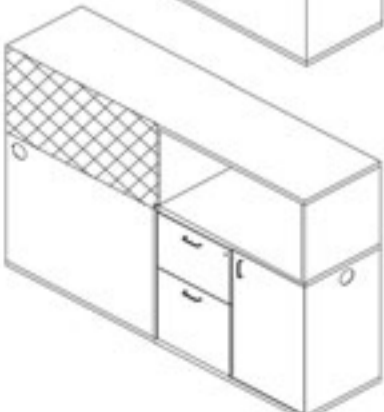
	description	size	code			
	single desking - managerial & pa size desk - freestanding - includes wire mesh cable tray - 2 wire management portholes - adjustable ferrules - steel frame available in white, black or silver - specify on order	1800(w) x 750(d) x 730(h) 1600(w) x 750(d) x 730(h) 1500(w) x 750(d) x 730(h) 1200(w) x 750(d) x 730(h)	DESK03 DESK04 DESK04A DESK05			
		dual desking - 2 x workstations - freestanding - including wire mesh cable tray - 2 wire management portholes - adjustable ferrules - centre leg on 1500, 1600, 1800 x 2000 - steel frame available in white, black or silver - specify on order	2000(w) x 1510(d) x 730(h) 1800(w) x 1510(d) x 730(h) 1600(w) x 1510(d) x 730(h) 1500(w) x 1510(d) x 730(h) 1200(w) x 1510(d) x 730(h)	DESK06 DESK07 DESK08 DESK13 DESK09		
			aluminium screens - single desk - aluminium frame available in white, black or silver - specify on order - 2 identity panels fit into frame - standard in vulcan colour or com specify colour on order - includes fixing brackets for fixing on single desk	850(w) x 360(d) Vulcan COM 1150(w) x 360(d) Vulcan COM 1450(w) x 360(d) Vulcan COM 1750(w) x 360(d) Vulcan COM	Z-MS021 Z-MS022 Z-MS023 Z-MS024 Z-MS025 Z-MS026 Z-MS027 Z-MS028	
				aluminium frame screens dual desk screens - aluminium frame available in white, black or silver - specify on order - 2 identity panels fit into frame - standard in vulcan colour or com specify colour on order - includes fixing brackets for fixing on dual desk	850 x 360 Vulcan COM 1150 x 360 Vulcan COM 1450 x 360 Vulcan COM 1750 x 360 Vulcan COM	Z-MS013 Z-MS014 Z-MS015 Z-MS016 Z-MS017 Z-MS018 Z-MS019 Z-MS020
					vertebra unit open top filer and pinboard left/right hand side - 2 way storage unit - cavity between top & bottom for reticulation - drop in pen & pencil tray - central locking drawers - in order to file suspended files order 400w cradles for A4 filing only	1800(w) x 450(d) x 1100(h) 1800(w) x 450(d) x 1100(h)
						

twentyfive50 vertebra with roller door top filer



The Vertebra storage system offers the perfect solutions for all the storage functionality you need: Filing, Organization, Versatility and Space Utilization.

The Vertebra storage system is made up of a modular top storage unit, and bottom storage unit.

The top storage unit is comprised of a pinboard section, and adjacent to the pinboard section, is a choice of either open storage or roller door storage compartments.

The bottom storage unit consists of a hinge door compartment, with a single shelf, and adjacent to the hinge door compartment, is a drawer unit consisting

of 2 drawers (One single drawer, with a drop in pen and pencil tray and one drawer as a deep filer). The Vertebra storage system has an integrated cable management

compartment, placed between the top and bottom storage units, and is primarily used for reticulation purposes. Power and data cables are conveniently delivered to workstations through cable management ports, located on the sides, middle and back of the Vertebra storage units.

twentyfive50 - vertebra with roller door top filer



description

single desking

- managerial & pa size desk
- freestanding
- includes wire mesh cable tray
- 2 wire management portholes
- adjustable ferrules
- steel frame available in white, black or silver - specify on order

1800(w) x 750(d) x 730(h)
 1600(w) x 750(d) x 730(h)
 1500(w) x 750(d) x 730(h)
 1200(w) x 750(d) x 730(h)

DESK03
 DESK04
 DESK04A
 DESK05



dual desking

- 2 x workstations
- freestanding
- including wire mesh cable tray
- 2 wire management portholes
- adjustable ferrules
- centre leg on 1500, 1600, 1800 x 2000
- steel frame available in white, black or silver - specify on order

2000(w) x 1510(d) x 730(h)
 1800(w) x 1510(d) x 730(h)
 1600(w) x 1510(d) x 730(h)
 1500(w) x 1510(d) x 730(h)
 1200(w) x 1510(d) x 730(h)

DESK06
 DESK07
 DESK08
 DESK13
 DESK09



aluminium screens - single desk

- aluminium frame available in white, black or silver - specify on order
- 2 identity panels fit into frame
- standard in vulcan colour or com specify colour on order
- includes fixing brackets for fixing on single desk

850(w) x 360(d) Vulcan
 COM
 1150(w) x 360(d) Vulcan
 COM
 1450(w) x 360(d) Vulcan
 COM
 1750(w) x 360(d) Vulcan
 COM

Z-MS021
 Z-MS022
 Z-MS023
 Z-MS024
 Z-MS025
 Z-MS026
 Z-MS027
 Z-MS028

aluminium frame screens dual desk screens

- aluminium frame available in white, black or silver - specify on order
- 2 identity panels fit into frame
- standard in vulcan colour or com specify colour on order
- includes fixing brackets for fixing on dual desk

850 x 360 Vulcan
 COM
 1150 x 360 Vulcan
 COM
 1450 x 360 Vulcan
 COM
 1750 x 360 Vulcan
 COM

Z-MS013
 Z-MS014
 Z-MS015
 Z-MS016
 Z-MS017
 Z-MS018
 Z-MS019
 Z-MS020

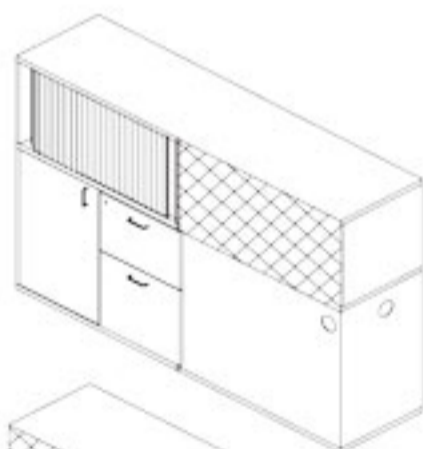

vertebra unit roller door top filer and pinboard left/right hand side

- 2 way storage unit
- cavity between top & bottom for reticulation
- drop in pen & pencil tray
- central locking drawers
- in order to file suspended files order 400w cradles for A4 filing only

1800(w) x 450(d) x 1100(h)
 1800(w) x 450(d) x 1100(h)



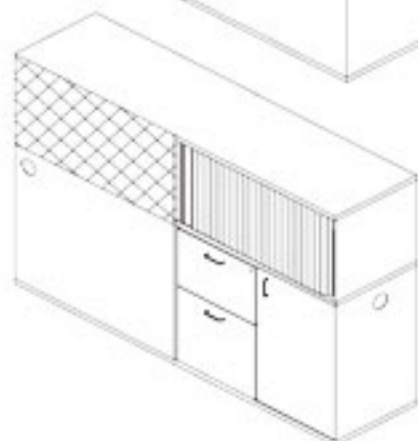



VERTDRL
 VERTDRR



twentyfive50 bench with multi storage





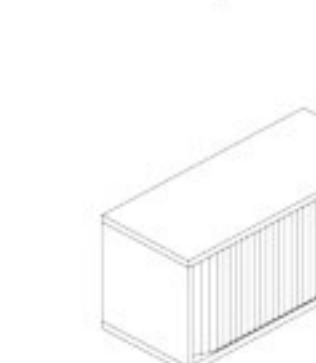

twentyfive50 - bench with multi storage

	description	size	code
	dual desk - 2 x workstations - freestanding - including wire mesh cable tray - 2 wire management portholes - adjustable ferrules - centre leg on 1500, 1600, 1800 & 2000 - steel frame available in white, black or silver - specify on order	2000(w) x 1510(d) x 730(h) 1800(w) x 1510(d) x 730(h) 1600(w) x 1510(d) x 730(h) 1500(w) x 1510(d) x 730(h) 1200(w) x 1510(d) x 730(h)	DESK06 DESK07 DESK08 DESK13 DESK09
	aluminium frame screens dual desk screens - aluminium frame available in white, black or silver - specify on order - 2 identity panels fit into frame - standard in vulcan colour or cam - specify colour on order - includes fixing brackets for fixing on dual desk		ZMS013 ZMS014 ZMS015 ZMS016 ZMS017 ZMS018 ZMS019 ZMS020
	top for pedestal - fits on top of desk height pedestal - 22mm top	400(w) x 750(d) 22mm top	TOP001
	2S1F deep filer desk height pedestal - central locking - drop in pen & pencil tray - including cut out on side of pedestal - in order to file suspended files order 400w cradles for a4 filing only	400(w) x 750(d) x 708(h)	PED018
	4S desk height pedestal - top locking only - drop in pen & pencil tray - including cut out on side of pedestal	400(w) x 750(d) x 708(h)	PED020
	2F deep filer desk height pedestal - central locking - drop in pen & pencil tray - including cut out on side of pedestal - in order to file suspended files order 400w cradles for A4 filing only	400(w) x 750(d) x 708(h)	PED019
	roller door top filer fitted to desk height pedestal left / right hand side - fits on top of desk height pedestal - 22mm top & bottom - roller door only & lockable	750(w) x 400(d) x 382(h)	PBOOK4

twentyfive50 bench with mobile storage

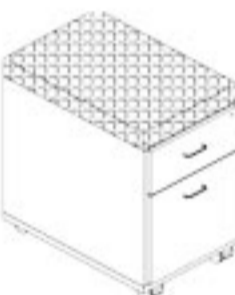

twentyfive50 - bench with mobile storage

	description	size	code
	dual desking	2000(w) x 1510(d) x 730(h)	DESK06
	- 2 x workstations	1800(w) x 1510(d) x 730(h)	DESK07
	- freestanding	1600(w) x 1510(d) x 730(h)	DESK08
	- including wire mesh cable tray	1500(w) x 1510(d) x 730(h)	DESK13
	- 2 wire management portholes	1200(w) x 1510(d) x 730(h)	DESK09
	- adjustable ferrules		
	- steel frame available in white, black or silver - specify on order		
	- centre leg on 1500, 1600, 1800 x 2000		
	single desking	1800(w) x 750(d) x 730(h)	DESK03
	- managerial & pa size desk	1600(w) x 750(d) x 730(h)	DESK04
	- freestanding	1500(w) x 750(d) x 730(h)	DESK04A
	- includes wire mesh cable tray	1200(w) x 750(d) x 730(h)	DESK05
	- 2 wire management portholes		
	- adjustable ferrules		
	- steel frame available in white, black or silver - specify on order		
	glass screens	1750(w) x 360(h)	X-TFF1
	- includes brackets	1450(w) x 360(h)	X-TFF2
	- available in clear & vinyl - specify on order	1150(w) x 360(h)	X-TFF3
	- dual desk brackets	850(w) x 360(h)	X-TFF4
	note: overall glass height with brackets 360(h)		
	1S1F mobile pedestal with cushion	400(w) x 525(d) x 630(h)	610
	- drop in pen & pencil tray		
	- central locking		
	- 4 weight bearing castors		
	- weight bearing 40kg per castor		
	- in order to file suspended files order 400w cradles for A4 filing only		
	- price include all vulcan fabric colours		
	- specify colour with order		
	3S mobile pedestal	400(w) x 525(d) x 590(h)	PB2007
	- central locking		
	- drop in pen & pencil tray		
	- 4 castors		
	- specify colour with order		
	desk top file fitted	750(w) x 300(d) x 360(h)	PBOOK5
	- fits on top of desk		
	- 16mm top & bottom		

twentyfive50 bench with tallboy



twentyfive50 bench with short boy



twentyfive50 bench call-center



twentyfive50 - bench with tallboy

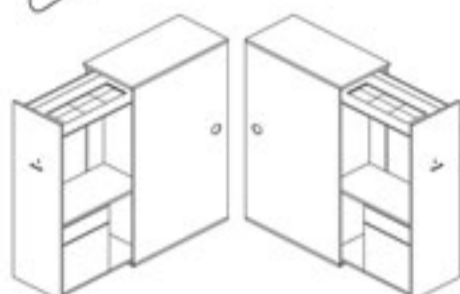

description	size	code
dual desking		
- 2 x workstations	2000(w) x 1510(d) x 730(h)	DESK06
- freestanding	1800(w) x 1510(d) x 730(h)	DESK07
- including wire mesh cable tray	1600(w) x 1510(d) x 730(h)	DESK08
- 2 wire management portholes	1500(w) x 1510(d) x 730(h)	DESK13
- adjustable ferrules	1200(w) x 1510(d) x 730(h)	DESK09
- steel frame available in white, black or silver - specify on order		
- centre leg on 1500, 1600, 1800 x 2000		
aluminium frame screens	850 x 360 Vulcan	Z-MS013
dual desk screens	COM	Z-MS014
- aluminium frame available in white, black or silver - specify on order	1150 x 360 Vulcan	Z-MS015
- 2 identity panels fit into frame	COM	Z-MS016
- standard in vulcan colour or com	1450 x 360 Vulcan	Z-MS017
- specify colour on order	COM	Z-MS018
- includes fixing brackets for fixing on dual desk	1750 x 360 Vulcan	Z-MS019
	COM	Z-MS020
tall boy multi-storage	450(w) x 750(d) x 1100(h) - lhs	TALLBOYL
left / right hand side	450(w) x 750(d) x 1100(h) - rhs	TALLBOYR
- pull out storage unit and 2 x drawers		
- drop in pen & pencil tray		
- lever arch filing compartment		
- lockable		
- wire management portholes - adjustable ferrules		

twentyfive50 - bench with short boy

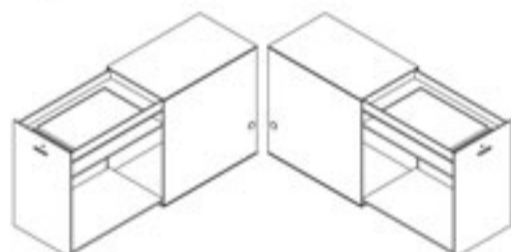

description	size	code
dual desking		
- 2 x workstations	2000(w) x 1510(d) x 730(h)	DESK06
- freestanding	1800(w) x 1510(d) x 730(h)	DESK07
- including wire mesh cable tray	1600(w) x 1510(d) x 730(h)	DESK08
- 2 wire management portholes	1500(w) x 1510(d) x 730(h)	DESK13
- adjustable ferrules	1200(w) x 1510(d) x 730(h)	DESK09
- steel frame available in white, black or silver - specify on order		
- centre leg on 1500, 1600, 1800 x 2000		
aluminium frame screens	850 x 360 Vulcan	Z-MS013
dual desk screens	COM	Z-MS014
- aluminium frame available in white, black or silver - specify on order	1150 x 360 Vulcan	Z-MS015
- 2 identity panels fit into frame	COM	Z-MS016
- standard in vulcan colour or com	1450 x 360 Vulcan	Z-MS017
- specify colour on order	COM	Z-MS018
- includes fixing brackets for fixing on dual desk	1750 x 360 Vulcan	Z-MS019
	COM	Z-MS020
short boy multi-storage	450(w) x 750(d) x 730(h)	SHORTBOYL
left / right hand side	450(w) x 750(d) x 730(h)	SHORTBOYR
- pull out storage unit and 1 drawer		
- drop in pen & pencil tray		
- lever arch filing compartment		
- lockable		
- wire management portholes, adjustable ferrules		

twentyfive50 - bench call-center



description	size	code
dual desking		
- 2 x workstations	1800(w) x 1510(d) x 730(h)	DESK07
- freestanding	1600(w) x 1510(d) x 730(h)	DESK08
- including wire mesh cable tray	1500(w) x 1510(d) x 730(h)	DESK13
- 2 wire management portholes	1200(w) x 1510(d) x 730(h)	DESK09
- adjustable ferrules		
- steel frame available in white, black or silver - specify on order		
sliding door storage cabinet	1510(w) x 500(d) x 1100(h)	CAB021
- 2 x 22mm laminate shelves		
- lockable		
intergrated aluminium desk based screen	refer to page 150 on the screen section	
fabric/lexan combo (including connecting brackets)		

twentyfive50 econoline own pedestal benching 4 way



twentyfive50 econoline own pedestal benching 2 way



twentyfive50 - econoline own pedestal benching 4 way



description	size	code
econoline dual B (desk for own pedestal - 2 way) must use 2x econoline pedestals with desk	1200(w) x 1510(d) x 730(h)	DESK15
- 1 dual B must be ordered to make 2 way - fixes onto econoline own pedestals - includes one wire mesh cable tray - 1 wire management port hole per top - adjustable ferrules - steel frame available in white, black or silver specify on order	1500(w) x 1510(d) x 730(h)	DESK16
glass screens includes brackets	1750(w) x 360(h)	X-TFF1
- available in clear & vinyl - specify on order	1450(w) x 360(h)	X-TFF2
- dual & single desk brackets	1150(w) x 360(h)	X-TFF3
	850(w) x 360(h)	X-TFF4
note: overall glass height with brackets 360(h)		
2S1F econoline own desk height pedestal - 2 drawers & 1 deep filer - drop in pen & pencil tray - drawers central locking - no top - in order to file suspended files order 300w cradles for A4 filing only	300(w) x 700(d) x 708(h)	PED006Q
open top filer fitted to desk height pedestal - fits on top of desk - 16mm top & bottom	750(w) x 300(d) x 360(h)	PBOOK5
sliding door storage cabinet - 2 x 22mm laminate shelves - lockable	1510(w) x 500(d) x 1100(h)	CAB021

twentyfive50 - econoline own pedestal benching 2 way



description	size	code
econoline single desk for own pedestal must use 1x econoline own pedestal with desks	1200(w) x 750(d) x 730(h)	DESK17
- fixes onto slim line pedestal	1500(w) x 750(d) x 730(h)	DESK18
- include 1 wire mesh cable tray	1600(w) x 750(d) x 730(h)	DESK19
- 1 wire management port hole - adjustable ferrules - steel frame available in white, black or silver - specify on order	1800(w) x 750(d) x 730(h)	DESK20
glass screens includes brackets	1750(w) x 360(h)	X-TFF1
- available in clear & vinyl - specify on order	1450(w) x 360(h)	X-TFF2
- total height 360(h)	1150(w) x 360(h)	X-TFF3
- dual & single desk brackets	850(w) x 360(h)	X-TFF4
2S1F econoline own desk height pedestal - 2 drawers & 1 deep filer - drop in pen & pencil tray - drawers central locking - no top - in order to file suspended files order 300w cradles for A4 filing only	300(w) x 700(d) x 708(h)	PED006Q
open top filer fitted to desk height pedestal - fits on top of desk height pedestal - 22mm top & bottom	750(w) x 300(d) x 360(h)	PBOOK5
note: overall glass height with brackets 360(h)		

twentyfive50 econoline shared pedestal call centre 4 way



twentyfive50 econoline shared pedestal call centre 2 way side - by - side



twentyfive50 - econoline shared pedestal call centre 4 way



description	size	code
econoline dual A (desk for shared pedestal)	1200(w) x 1510(d) x 730(h)	DESK11
must use 2x econoline pedestal with 4 way	1500(w) x 1510(d) x 730(h)	DESK12
<ul style="list-style-type: none"> - 2 dual a must be ordered to make 4 way - fixes onto 2 x econoline shared pedestals - includes one wire mesh cable tray per dual A - 1 wire management port hole per top - adjustable ferrules - steel frame available in white, black or silver specify on order 		



glass screens	1750(w) x 360(h)	X-TFF1
includes brackets	1450(w) x 360(h)	X-TFF2
- available in clear & vinyl - specify on order	1150(w) x 360(h)	X-TFF3
- dual & single desk brackets	850(w) x 360(h)	X-TFF4

note: overall glass height with brackets 360(h)



econoline shared pedestal	300(w) x 700(d) x 708(h)	PED022
2 door		
<ul style="list-style-type: none"> - 2 hinge door storage compartments - doors lockable - no top 		

twentyfive50 - econoline shared pedestal call centre 2 way side - by - side



description	size	code
econoline two way (side by side with shared pedestal)	2400(w) x 750(d) x 730(h)	DESK10
must use 1x econoline shared pedestal with desk		
<ul style="list-style-type: none"> - 2 x 1200 workstations - fixes onto econoline shared pedestal - includes 2 wire mesh cable trays - 1 wire management port hole per top - adjustable ferrules - steel frame available in white, black or silver - specify on order 		



glass screens	1750(w) x 360(h)	X-TFF1
includes brackets	1450(w) x 360(h)	X-TFF2
- available in clear & vinyl - specify on order	1150(w) x 360(h)	X-TFF3
- dual & single desk brackets	850(w) x 360(h)	X-TFF4

note: overall glass height with brackets 360(h)



econoline shared pedestal	300(w) x 700(d) x 708(h)	PED022
2 door		
<ul style="list-style-type: none"> - 2 hinge door storage compartments - doors lockable - no top 		



twentyfive50 reception



twentyfive50 canteen & meeting table

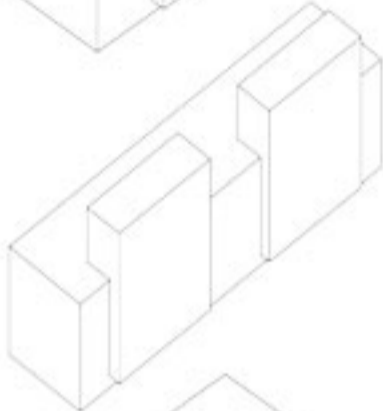

twentyfive50 - reception

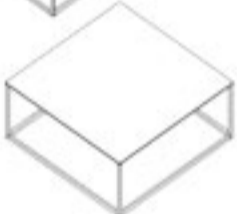



	description	size	code
	welcome reception unit - single station	1800(w) x 800(d) x 1100(h) 2000(w) x 800(d) x 1100(h)	TTFREC1 TTFREC2
		welcome reception unit - double station	3600(w) x 800(d) x 1100(h)
 	welcome coffee table - steel frame - assembled - 16mm top - steel frame available in white, black or silver - specify on order	1200(w) x 600(d) x 410(h) 800(w) x 600(d) x 410(h) 800(w) x 800(d) x 410(h)	TTFCOF1 TTFCOF2 TTFCOF3

twentyfive50 - canteen & meeting table

	description	size	code
	900 top - 22 mm top - 700 cross base 25/50 - steel frame available in white, black or silver specify on order	900mm round	CANTABLE01
	1200 top - 22mm top - 900 cross base 25/50 - steel frame available in white, black or silver specify on order	1200mm round	CANTABLE02
	server unit 2 door 5 drawer - include 2 shelves - 2 hinge doors - 5 drawers - accommodates std bar fridge	1800(w) x 600(d) x 900(h)	TTFSERV1

product list

twentyfive50-steel desking

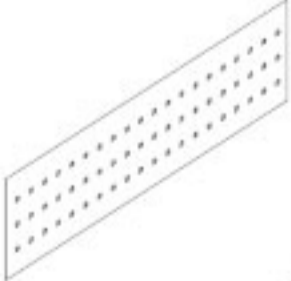
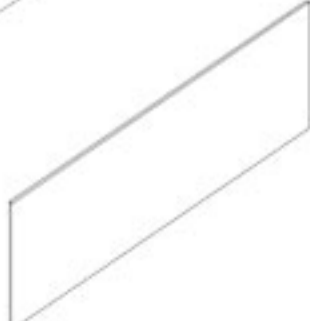
	description	size			code
		(w)	x (d)	x (h)	
	executive desking	2000 x 1000 x 730			DESK01
	- freestanding - includes wire mesh cable tray - 2 wire management portholes - adjustable ferrules - steel frame available in white, black or silver - specify on order	1800 x 900 x 730			DESK02
	managerial & p.a desking	1800 x 750 x 730			DESK03
	- managerial & pa size desk	1600 x 750 x 730			DESK04
	- freestanding	1500 x 750 x 730			DESK04A
	- includes wire mesh cable tray - 2 wire management portholes - adjustable ferrules - steel frame available in white, black or silver - specify on order	1200 x 750 x 730			DESK05
	dual desking	2000 x 1510 x 730			DESK06
	- 2 x workstations - freestanding	1800 x 1510 x 730			DESK07
	- including wire mesh cable tray - 2 wire management portholes - adjustable ferrules	1600 x 1510 x 730			DESK08
	- centre leg on 1500, 1600, 1800 & 2000	1500 x 1510 x 730			DESK13
	- steel frame available in white, black or silver - specify on order	1200 x 1510 x 730			DESK09
	L/extension	750 x 600 x 730			LEXT01
	- 600mm leg & 2 cross beams - beams attach on main desk beam	1050 x 600 x 730			LEXT02
	- fits onto all straight, dual & executive steel desks - includes 2 x small link plates - adjustable ferrules - steel frame available in white, black or silver - specify on order				
	modesty panels steel	1600 x 350/2000			Z - MS009
	- includes brackets	1400 x 350/1800			Z - MS010
	- steel modesty available in white, black or silver - specify on order	1200 x 350/1500/1600			Z - MS011
		900 x 350/1200			Z - MS012
	modesty panels wooden	1800 x 350 x 16mm			MOD01
	- includes brackets & screws	1500 x 350 x 16mm			MOD02
		1200 x 350 x 16mm			MOD03
		900 x 350 x 16mm			MOD04

twentyfive50 desk based screens



description	size			code
	(w)	(d)	(h)	
aluminium frame screens	850	360	Vulcan	Z-MS013
dual desk screens	COM			Z-MS014
- aluminium frame available in white, black or silver specify on order	1150	360	Vulcan	Z-MS015
- 2 identity panels fit into frame	COM			Z-MS016
- standard in vulcan colour or com specify colour on order	1450	360	Vulcan	Z-MS017
- includes fixing brackets for fixing on dual desk	COM			Z-MS018
	1750	360	Vulcan	Z-MS019
	COM			Z-MS020
aluminium screens - single desk	850	360	Vulcan	Z-MS021
- aluminium frame available in white, black or silver - specify on order	COM			Z-MS022
- 2 identity panels fit into frame	1150	360	Vulcan	Z-MS023
- standard in vulcan colour or com specify colour on order	COM			Z-MS024
- includes fixing brackets for fixing on single desk	1450	360	Vulcan	Z-MS025
	COM			Z-MS026
	1750	360	Vulcan	Z-MS027
	COM			Z-MS028
aluminium screens - return screen	700	360	Vulcan	Z-MS029
- aluminium frame available in white, black or silver - specify on order	COM			Z-MS030
- 2 identity panels fit into frame				
- standard in vulcan colour or com specify colour on order				
- includes fixing brackets				
glass screens				
- includes brackets	1750	360		X-TFF1
- available in clear & vinyl - specify on order	1450	360		X-TFF2
- total height 360(h)	1150	360		X-TFF3
- dual & single desk brackets	850	360		X-TFF4
NOTE: OVERALL GLASS HEIGHT WITH BRACKETS 360(H)	700	360		X-TFF5
			Return Screen	

twentyfive50 econoline

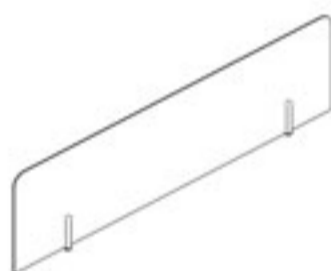
description	size			code
	(w)	(d)	(h)	
econoline single desk for own pedestal	1200	750	730	DESK17
must use 1x econonline own pedestal with desks	1500	750	730	DESK18
- fixes onto slim line pedestal	1600	750	730	DESK19
- include 1 wire mesh cable tray	1800	750	730	DESK20
- 1 wire management port hole				
- adjustable ferrules				
- steel frame available in white, black or silver - specify on order				



twentyfive50 econoline

	description	size			code
		(w)	x (d)	x (h)	
	<p>econoline two way (side by side with shared pedestal) must use 1x econoline shared pedestal with desks</p> <ul style="list-style-type: none"> - 2 x 1200 workstations - fixes onto econoline shared pedestal - includes 2 wire mesh cable trays - 1 wire management port hole per top - adjustable ferrules - steel frame available in white, black or silver - specify on order 	2400	x 750	x 730	DESK10
	<p>econoline dual A (desk for shared pedestal - 4 way) must use 2x econoline pedestal with 4 way</p> <ul style="list-style-type: none"> - 2 dual a must be ordered to make 4 way - fixes onto 2 x econoline shared pedestals - includes one wire mesh cable tray per dual a - 1 wire management port hole per top - adjustable ferrules - steel frame available in white, black or silver specify on order 	1200	x 1510	x 730	DESK11
	<p>econoline dual B (desk for own pedestal - 2 way) must use 2x econoline pedestals with desk</p> <ul style="list-style-type: none"> - 1 dual b must be ordered to make 2 way - fixes onto econoline own pedestals - includes one wire mesh cable tray - 1 wire management port hole per top - adjustable ferrules - steel frame available in white, black or silver specify on order 	1200	x 1510	x 730	DESK15
		1500	x 1510	x 730	DESK12
					DESK16

twentyfive50 econoline

	description	size			code
		(w)	x (d)	x (h)	
	<p>251F econoline own desk height pedestal</p> <ul style="list-style-type: none"> - 2 drawers & 1 deep filer - drop in pen & pencil tray - drawers central locking - no top - in order to file suspended files order 300w cradles for A4 filing only 	300	x 700	x 708	PED006Q
	<p>econoline shared pedestal 2 door</p> <ul style="list-style-type: none"> - 2 hinge door storage compartments - doors lockable - no top 	300	x 700	x 708	PED022

twentyfive50 welcome reception range

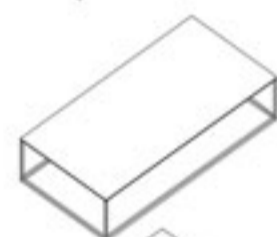
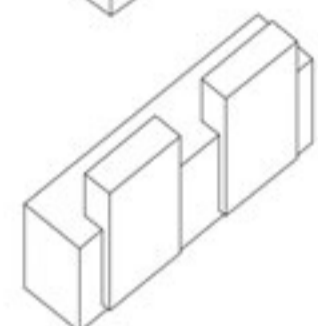
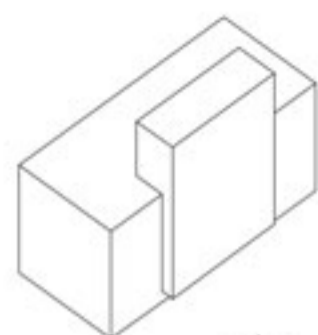

description	size			code
	(w)	(d)	(h)	
welcome reception unit	1800	800	1100	TTREC1
- single station	2000	800	1100	TTREC2
welcome reception unit				
- double station	3600	800	1100	TTREC3
welcome coffee table	1200	600	410	TTCOF1
- steel frame	800	600	410	TTCOF2
- assembled	800	800	410	TTCOF3
- 16mm top				
- steel frame available in white, black or silver - specify on order				

twenty five50 boardroom & meeting



description	size			code
	(w)	(d)	(h)	
boardroom table				
- 2 cross beams no centre leg	1800	900	730	TTBOARD1
- 4 cross beams no centre leg	1800	1200	730	TTBOARD2
- 4 cross beams 2 centre leg	2400	1200	730	TTBOARD3
- 4 cross beams 2 centre leg	2700	1200	730	TTBOARD4
- steel frame available in white, black or silver specify on order				
meeting tables				
- 4 cross beams no centre leg	1200	1200	730	TFMEET1
- 4 cross beams no centre leg	1500	1510	730	TFMEET2
- 2 cross beams no centre leg	900	900	730	TFMEET5
- steel frame available in white, black or silver - specify on order				
standing meeting table	1800	900	1022	TFMEET3
- 2 cross beams support under top	1500	900	1022	TFMEET4
- base frame structure				
- steel frame available in white, black or silver - specify on order				

twenty five50 boardroom & meeting



description	size			code
	(w)	(d)	(h)	

server unit 2 door 5 drawer	1800	600	950	TTFSERV1
-----------------------------	------	-----	-----	----------

- include 2 shelves
- 2 hinge doors
- 5 drawers
- accommodates std bar fridge

server unit 3 door	1500	600	950	TTFSERV2
--------------------	------	-----	-----	----------

- includes 3 shelves
- 3 hinge doors
- accommodates std bar fridge

twentyfive50storage

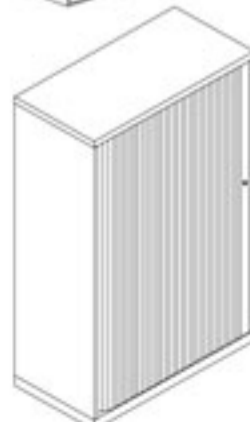
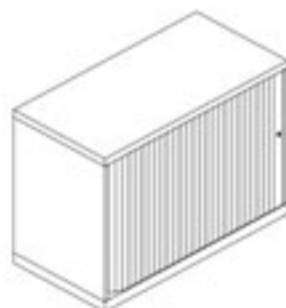

description	size			code
	(w)	(d)	(h)	

hinge door pedenza	900	450	730	(rhs)	PEDTFF5
	900	450	730	(lhs)	PEDTFF6

- left / right hand side
- 2 std drawers & 1 deep filler drawer
- central locking + door lock
- power management outlets
- in order to file suspended files order 400w cradles for A4 filing only
- laminated shelf

roller door credenza	1200	500	730	(silver)	CRETFF1
				(charcoal)	CRETFF2
	900	500	730	(silver)	CRETFF3
				(charcoal)	CRETFF4

- excludes shelves
- need to order 3/3 shelf for 1200mm
- need to order 2/3 shelf for 900mm
- add shelves from steel components

pedenza - lhs	1250	500	730	(silver)	PEDTFF1L
				(charcoal)	PEDTFF2L





- 2s1f drawers
- drop in pen & pencil tray
- excludes shelves
- need to order 2/3 shelf - steel components
- storage bracket
- in order to file suspended files order 400w cradles for A4 filing only

pedenza - rhs	1250	500	730	(silver)	PEDTFF1R
				(charcoal)	PEDTFF2R



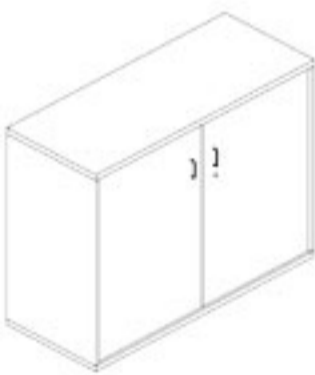

roller door cabinet	1200	500	1500	(silver r/d)	CAB003A
	900	500	1500	(silver r/d)	CAB004A
				(charcoal r/d)	CAB003
	900	500	1500	(charcoal r/d)	CAB004

- Lockable
- Top and bottom 22mm
- Excludes shelves
- Need to order 3/3 shelf for 1200mm
- Need to order 2/3 shelf for 900mm
- Add Shelves from Steel Components

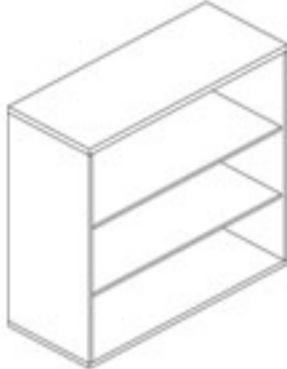

twenty five50 storage

	description	size			code
		(w)	x (d)	x (h)	
	hinge door cabinet - lockable - top and bottom 22mm - excludes shelves - need to order 3/3 shelf for 1100mm - need to order 860 shelf for 900mm - add shelves from steel components	1100 x 500 x 1500 900 x 500 x 1500			CAB006 CAB011
	steel components for credenza/pedenna - 3/3 shelves including shelf clips - 2/3 shelves including shelf clips - 860 shelves including shelf clips		3/3 Shelf 2/3 Shelf 860 Shelf		Z33S Z33C Z23S Z23C Z860S Z860C
	personal assistant organiser - for use on top of 1200 credenza		1200 x 350 x 790		PA01
	wall unit base - includes 1 22mm laminate shelf		900 x 500 x 900		WUNBA
	wall unit top with glass doors - including 2 x 22mm laminate shelves		900 x 350 x 800		WUNTOPG

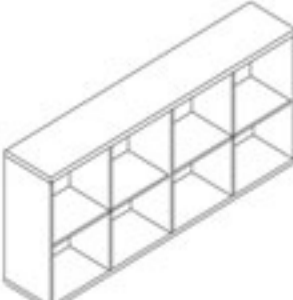

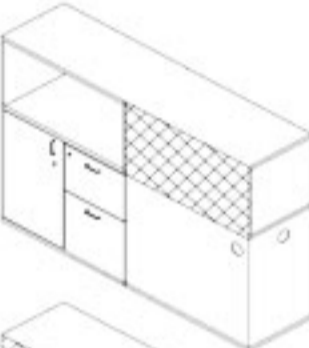

twentyfive50storage

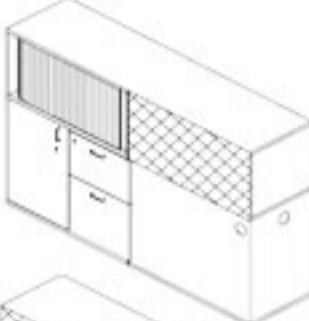
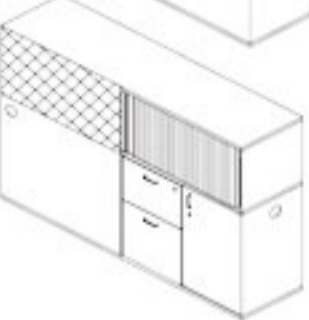
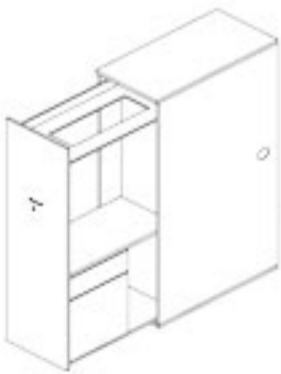
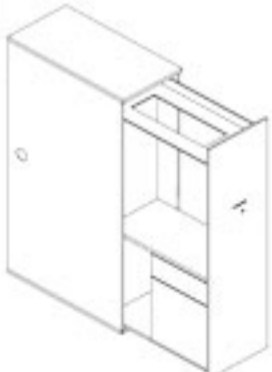
	description	size			code
		(w)	x (d)	x (h)	
	wall unit top open - 2 adjustable 22mm shelves	900	x 350	x 800	WUNTOPO
	1S1F mobile pedestal - drop in pen & pencil tray - central locking - 4 castor wheels - in order to file suspended files order 400w cradles for A4 filing only	400	x 525	x 590	PB2009
	3S mobile pedestal - drop in pen & pencil tray - central locking - 4 castor wheels	400	x 525	x 590	PB2007
	1S1F mobile pedestal with cushion - central locking - drop in pen & pencil tray - 4 weight bearing castors - weight bearing 40kg per castor - price include all vulcan fabric colours - specify colour with order - in order to file suspended files order 400w cradles for A4 filing only	400	x 525	x 630	610
	3S mobile pedestal with cushion - central locking - drop in pen & pencil tray - solid 22mm base - 4 weight bearing castors - weight bearing 40kg per castor - price includes all vulcan fabric colours - specify colour with order	400	x 525	x 630	630
	8 div pigeon organiser - 22mm top & bottom - fits lever arch files	1510	x 500	x 1100	PIG8DIV

twenty five50 storage

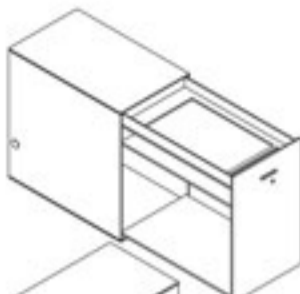
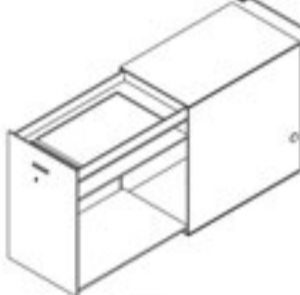
	description	size			code
		(w)	x (d)	x (h)	
	sliding door storage cabinet - including 2 x 22mm laminate shelves - lockable	1510	x 500	x 1100	CAB021 CAB022
	vertebra unit open top left / right hand side - 2 way storage unit - cavity between top & bottom for reticulation - drop in pen & pencil tray - central locking drawers - in order to file suspended files order 400w cradles for A4 filing only	1800	x 450	x 1100	VERTOPL VERTOPR
					
	vertebra unit silver roller door top left / right hand side - 2 way storage unit - cavity between top & bottom for reticulation - drop in pen & pencil tray - central locking drawers - in order to file suspended files order 400w cradles for A4 filing only	1800	x 450	x 1100	VERTDRL VERTDRR
					
	tall boy multi-storage left / right hand side - pull out storage unit - 2 x drawers - drop in pen & pencil tray - lever arch filing compartment - lockable - wire management portholes - adjustable ferrules	450	x 750	x 1100	TALLBOYL TALLBOYR
					

twenty five50 storage

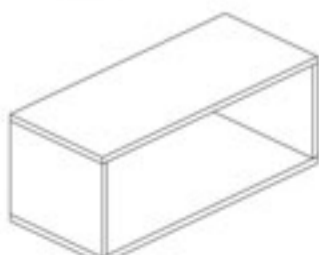
	description	size			code
		(w)	x (d)	x (h)	
	short boy multi-storage left / right hand side - pull out storage unit and 1 drawer - drop in pen & pencil tray - lever arch filing compartment - lockable - wire management portholes, adjustable ferrules	450 x 750 x 730			SHORTBOYL
		450 x 750 x 730			SHORTBOYR
	2S1F deep filer desk height pedestal - central locking - drop in pen & pencil tray - including cut out on side of pedestal - in order to file suspended files order 400w cradles for a4 filing only	400 x 750 x 708			PED018
	2F deep filer desk height pedestal - central locking - drop in pen & pencil tray - including cut out on side of pedestal - in order to file suspended files order 400w cradles for a4 filing only	400 x 750 x 708			PED019
	4S desk height pedestal - top locking only - drop in pen & pencil tray - including cut out on side of pedestal	400 x 750 x 708			PED020
	top for pedastal - fits on top of desk height pedestal - 22mm top	400 x 750 x 22mm			TOP001
	open top filer fitted to desk height pedestal - fits on top of desk height pedestal - 22mm top & bottom	750 x 400 x 382			PBOOK3

twenty five50 storage



roller door top filer
fitted to desk height pedestal

- fits on top of desk height pedestal
- 22mm top & bottom
- roller door only & lockable

750 x 400 x 382 PBOOK4

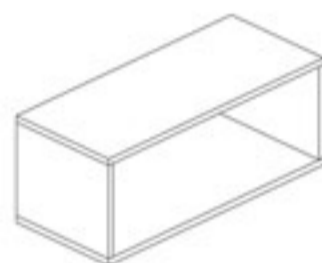

desk top open filer

- fits on top of desk
- 16mm top & bottom

750 x 300 x 360 PBOOK5

twenty five50 canteen & meeting table



description

size

code

(w) x (d) x (h)

canteen table

900mm round

CANTABLE01

- 900mm - 22 mm top
- with 700 cross base 25/50
- steel frame available in white, black or silver specify on order

meeting table

1200mm round

CANTABLE02

- 1200mm top - 22mm top
- 900 cross base 25/50
- steel frame available in white, black or silver specify on order



in the office
FURNITURE

MAKE YOUR WORKPLACE A HAPPY SPACE

Contact Adel on 063 246 2997 or Michael on 083 627 8203
adel@itofurniture.co.za or michael@itofurniture.co.za
www.itofurniture.co.za